

# RX

# TUNING GUIDE

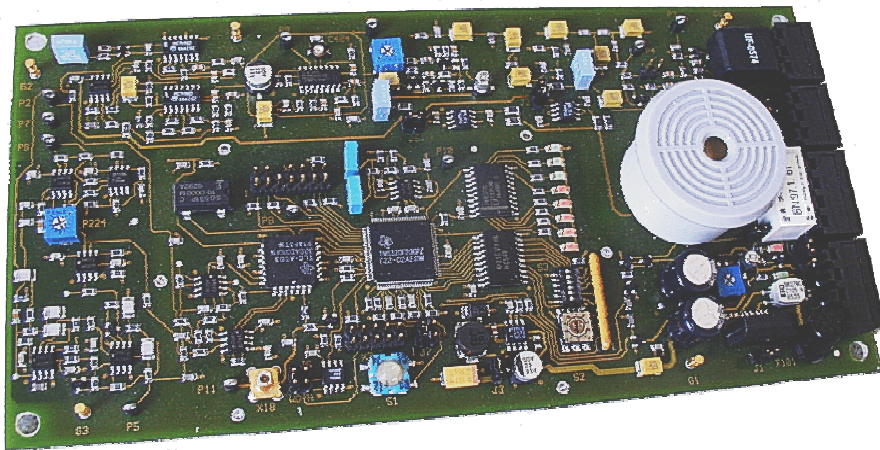

# URB-100

## Table of Contents

	Page
<b>1. Basic Description, Receiver Electronics.....</b>	<b>3</b>
1.1. Analog Part .....	3
1.2. Digital Part .....	3
1.3. Power/Alarm Part.....	4
<b>2. Description of Features .....</b>	<b>4</b>
2.1. Manually Adjustable RF Gain.....	4
2.2. Air Synchronization .....	4
2.3. Synchronous Demodulator.....	4
2.4. Beat Note Filter .....	4
2.5. Software Click Filter with Adaptive Slope .....	4
2.6. Software Spike Blanker .....	4
2.7. Accept Counter .....	5
2.8. Threshold Calculation .....	5
2.9. Alarm Threshold Margin Settings .....	5
<b>3. Tuning.....</b>	<b>6</b>
3.1. Philosophy .....	6
3.2. Recommended Tools .....	6
3.3. Receiver Preparatory Steps .....	6
3.3.1. Preparation.....	6
3.4. Receiver Tuning.....	8
3.4.1. RF Gain Adjustment.....	8
3.4.2. Beat Note Adjustment .....	10
3.4.3. Signal/Noise Level Check .....	11
3.4.4. DIL Switch Settings .....	12
3.5. Alarm Adjustments.....	12
3.6. Quick Check .....	13
3.6.1. Basics .....	13
3.6.2. RF-Gain Check.....	13
3.6.3. Beat Note Check.....	14
3.6.4. Signal/Noise Check.....	15
<b>4. Appendix .....</b>	<b>16</b>
4.1. Technical Specifications.....	16
4.2. Tuning Flowchart .....	17
4.3. X3 Connector Layout (External Alarm Unit).....	18
4.4. DIL Switch Settings.....	19
4.5. Rotary Switch Settings .....	20
4.6. Test Points .....	21
4.7. Jumper Settings .....	22
4.8. Compressed Overview .....	23

## 1. Basic Description, Receiver Electronics

The URB-100 receiver board consists of a:

- Analog Part
- Digital Part
- Power / Alarm Part

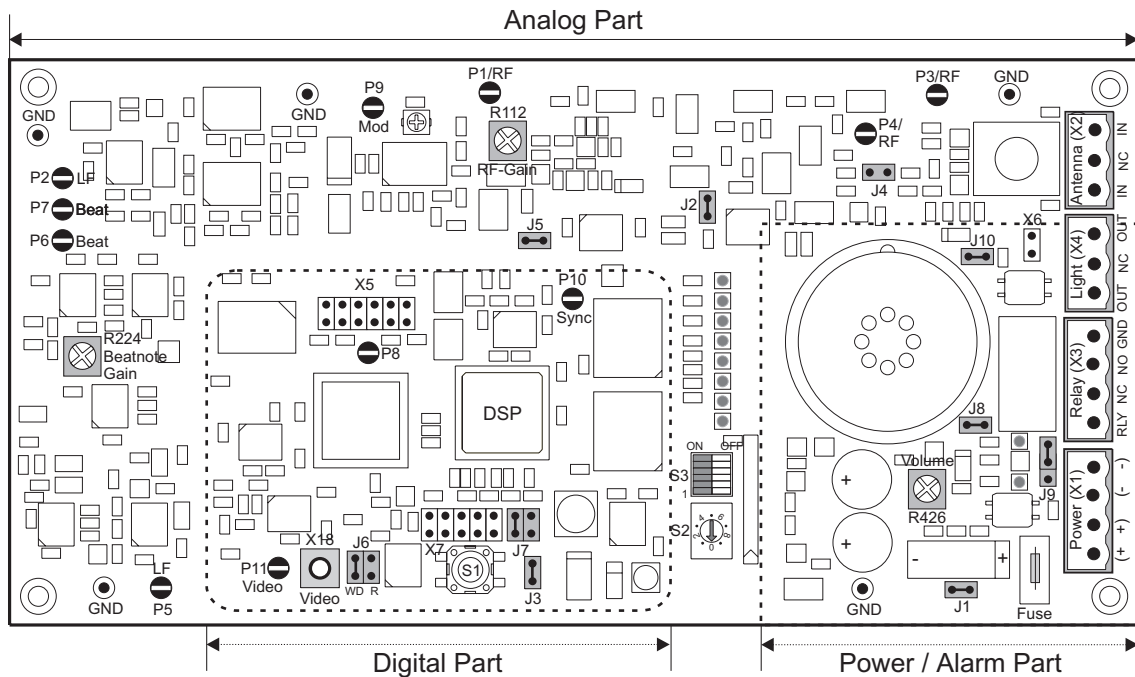

Receiver Board

### 1.1. Analog Part

The first input stage amplifies the received RF signal. If this signal is too large, the gain of the first input stage can be reduced using jumper J4 (Narrow or Wide position).

The next stage is a band-pass filter having a frequency range between 7.2 to 9.2 MHz. If necessary, the gain of the RF amplifier following the band-pass filter can be changed with potentiometer R112 (RF-Gain). An AGC is not built in, this gives a controlled RF amplification. The amplitude of the tag signal is pre-regulated by a fixed resistor. The DSP synchronization is done through "air", that is extracted from the received transmitter signal. A beat note circuit is implemented. This circuit is inhibiting spikes, radio transmitters and other signals with a very high Q factor.

### 1.2. Digital Part

The analog tag signal is A/D converted and sampled. The DSP (40 MIPS) filters the demodulated LF signal and stores the result in a memory. It processes this data and if all alarm criteria are met, it triggers an alarm.

DIL and rotary octal switches allow adjusting the software parameters and test positions.

### 1.3. Power / Alarm Part

Power is supplied to the receiver electronics by applying 20-24 VDC or 18-20 VAC to the power supply/power filter part. The integrated filter is used to reduce any interference picked up on the incoming line from the power supply.

An audible alarm (buzzer) is mounted on the filter part. Outputs for the antenna lamp and an external alarm are provided.

The volume of the buzzer is adjustable with the Volume potentiometer (R426). A jumper (J10) on the filter part allows setting the buzzer for continuous or intermittent (optional) tone. The duration of the audible alarm is about 2 seconds. The duration of the alarm light is about 10 seconds.

## 2. Description of Features

### 2.1. Manually Adjustable RF Gain

RF gain needs to be adjusted depending on the antenna type and the aisle width. In tuning mode S2=7 the RF level is shown on the scope and can be adjusted with (RF Gain) R112. With jumper J4 (RF attenuator) an additional attenuation of 10 dB can be selected.

### 2.2. Air Synchronization

The sweep information is extracted by a PLL, which is factory adjusted.

### 2.3. Synchronous Demodulator

The synchronous demodulator has a wide linear input range of 50 mVpp to 600 mVpp and high conversion gain. If the maximum level is exceeded, then the receiver is muted and the Inhibit (LED-4) status is on.

### 2.4. Beat Note Filter

The beat note filter detects carrier signals that are crossing (beating) the system sweep. If the signal is too strong then DSP blanks it out. The sensitivity is adjustable with (Beat Note Gain) R224. The beat note filter is active when LED-5 is flashing.

### 2.5. Software Click Filter with Adaptive Slope

Normally a demodulated tag signal is smooth. When the slewrates of a signal is too fast, this is an indication of induced noise and will be blanked out by the DSP. Some Hi-Q tags can trigger the filter. In that case it can be switched off with S3-5. Click filtering is active when LED-6 is flashing.

### 2.6. Software Spike Blanker

The spike blanker counts the number of samples that are above a certain level. The level is about 50% of the actual alarm threshold. When a preset limit of counts is exceeded then the blocking acts, thus preventing false alarms in a noisy environment. The blanking is visible on LED-7.

## 2.7. Accept Counter

The accept counter counts the number of consecutive sweeps detecting a tag. If the limit is reached in both sweeps, then an alarm is generated. The default is 24 sweeps, which gives approximated 300 ms response time. A faster response time can be selected with S3-3.

## 2.8. Threshold Calculation

The threshold level is based on the signals plus noise averaged over the detection sweep. Under normal condition this would prevent from triggering an alarm because the threshold rises with increasing tag signal. The threshold is therefore delayed by approx. 1.5 seconds. This is roughly the time you have to trigger the alarm at full sensitivity. With the same time delay the system is back to full sensitivity again.

## 2.9. Alarm Threshold Margin Settings

With switch S3-1 and S3-2 it is possible to adjust the alarm margin in 4 steps of 3 dB. The actual margin (peak signal to alarm threshold) is displayed on the LED Levelmeter. The actual alarm threshold level can be observed on the scope output.

### 3. Tuning

#### 3.1. Philosophy

A system will be put into operation as follows:

- First the TX (all) has to be prepared and then tuned.
- Second the RX (s) has to be prepared and then tuned.
- Third set the alarm conditions and make a final check. After this procedure the system is ready for operation.

If an already installed system needs to be checked, the Quick Check procedure may give a first indication about the system status.

An overview about the expert tuning and/or quick check procedures is given in a flow chart.

#### 3.2. Recommended Tools

The following instruments are necessary for tuning:

- Multimeter
- Battery-powered oscilloscope (analog) with two channels (minimum 20 MHz bandwidth).
- 10:1 oscilloscope probes
- Recommended: SMB cable (female/female, 1 meter/3 feet) plus BNC/SMB adapter (male/male). Radiall P/N R285215 and R191209.
- Recommended: Sweep Span Meter (e.g. XRST-1 crosspoint.nl) or equal. The SSM displays the minimum, maximum, center and the sweep frequency of a swept RF signal.

### 3.3. Receiver Preparatory Steps

#### 3.3.1. Preparation

- Remove power from the RX board by removing the PWR connector at socket X2.
- Verify the default jumper J1 to J9 settings (J4 and J6 are under the shield). See table and layout.

Jumper	(J1)	(J2)	(J3)	J4	(J5)	(J6/WD)	(J7)	J8	J9	J10
Setting	IN	IN	IN	OUT	IN	IN	IN	IN	EXT	IN
Remark	() = Factory use only			Wide/ Narrow	() = Factory			Sound ON/OFF	Remote Alarm	Sound

**RX Default Jumper Settings**

TUNING

- Verify that the antenna wires are connected to connector X2. The antenna wires must be connected to terminal 1 and 3.

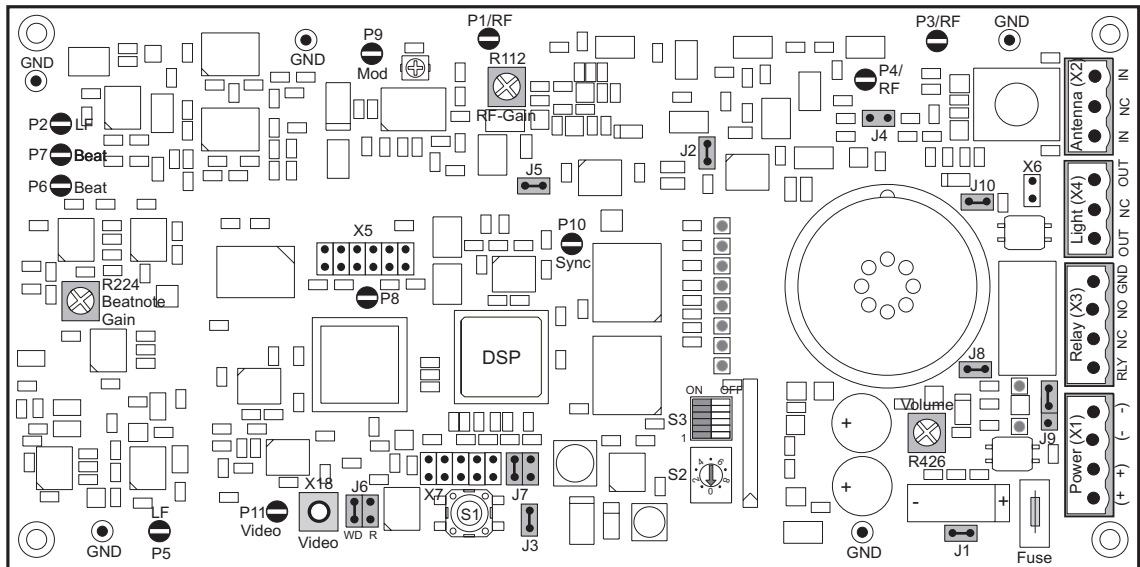

RX Default Jumper Settings Layout

- Set the Rotary switch (S2) to the 0 position and all six (6) DIL (S3) switches to the ON position. These are the default settings.

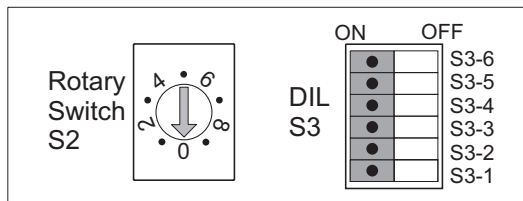

Rotary and DIL Switch Default Settings

### 3.4. Receiver Tuning

#### 3.4.1. RF Gain Adjustment

- Apply power to the RX board (X1 Power connector).
- Turn the Beat Note-Gain (R224) potentiometer counter clockwise to the minimum position.
- Turn the RF-Gain (R112) potentiometer counter clockwise to the minimum position.
- Connect the oscilloscope probe (**100 mVpp/Div.**) to P11-Video or X18-Video.

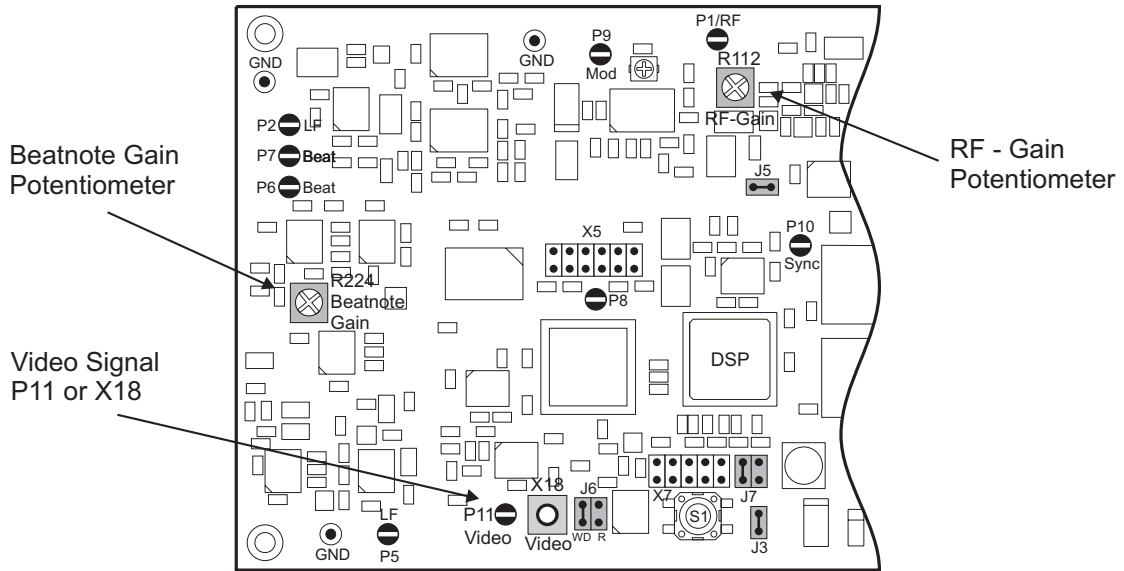

**RF Adjustment Controls**

- Set the sweep time to **2 ms/Div.** Synchronize to the negative pulse. The figures below explain the video signal in detail.

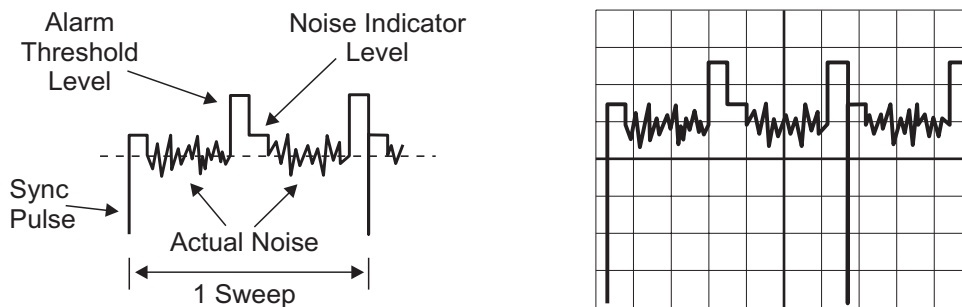

**Video Signal without a Tag Signal**



- Set Rotary switch to position 7 (RF-Gain Adjustment). Let all DIL switches in the ON position.

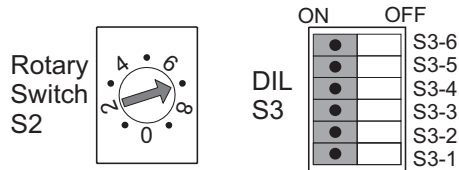

- Check the signal. The signal form could look like the figure below.

Caution: The lower part of the signal form can vary, depending on the antenna impedance and/or the environment.

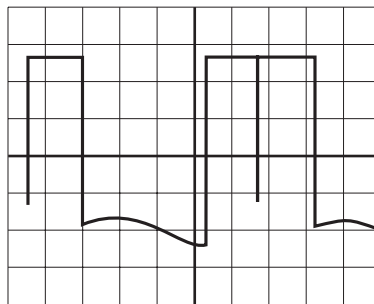

RF-Signal

- Turn the RF-Gain potentiometer until the signal looks similar to the figure below.

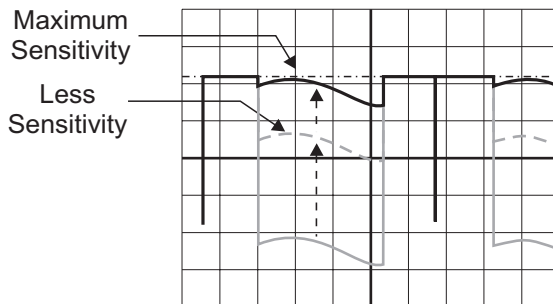

Perfect RF-Signal Adjustment

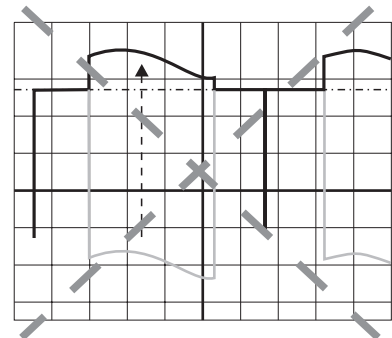

Wrong (system blocked)

**Rule:** Nothing of the curved part of the signal should be higher than the flat part of it. However its top should be as high as possible.

If the signal is not adjustable, following the given rule (e.g. small aisle width):

- Insert J4 (Wide / **Narrow**).
- Reduce TX output power.

### 3.4.2. Beat Note Adjustment

- Set Rotary switch to position 3 (LF signal before correlation).

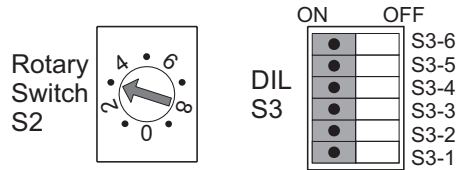

- Check the signals on the figure below.

Caution: If high deactivator signal amplitudes are present (like in the figure below). The deactivator(s) must be switched off for the following Beat Note adjustment.

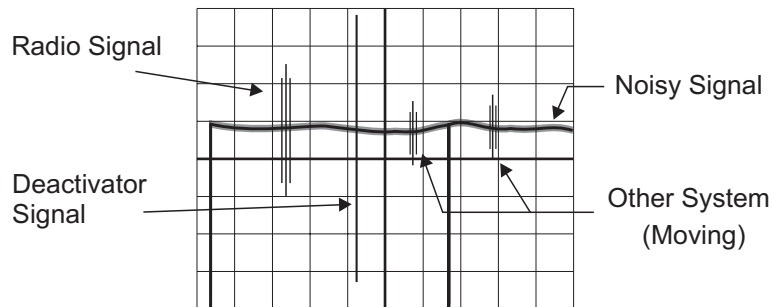

Different Signal Sources

- Set Rotary switch to position 4 (Beat Noted, LF signal).

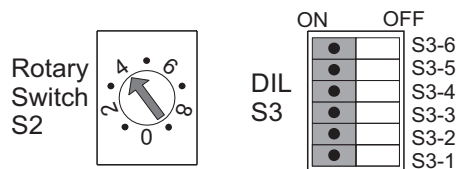

- Turn the Beat Note potentiometer until the signal looks similar to the figure below.

Caution: If the potentiometer is turned too much clockwise, the sensitivity will be reduced until the system is blocked.

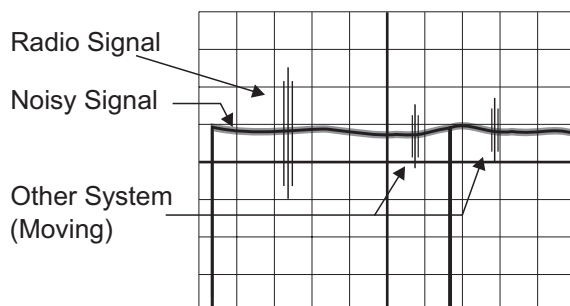

Before Adjustment

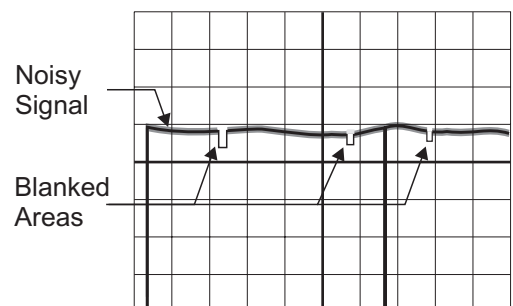

After Adjustment

**Remark:** The ground line of the above three pictures can vary.

### 3.4.3. Signal/Noise Level Check

- Set Rotary switch to position 0 (Running/Default Mode).

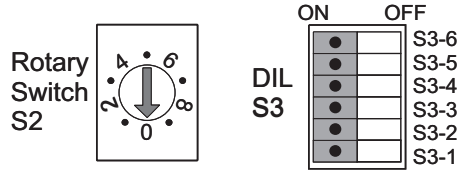

- Check the level of the actual noise. It is normally in the range between 50 to 150 mVpp.
- Hold the reference tag or label in front carry position in to the system and check the signal level: An alarm will be triggered if the tag signal exceeds the Alarm Threshold (which is set by default 3 times the Noise Indicator Level).

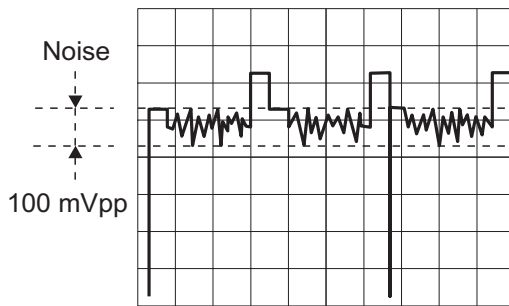

Noise

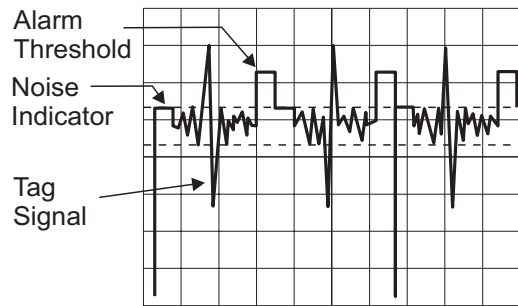

Tag Signal + Noise

If the Tag Signal level is much too high comparing to the alarm threshold:

- Set A/N Ratio to 4.5:1 (DIL switch S3-1 to the OFF position) or see DIL Switch Table in chapter 3.4.4.
- Reduce the system sensitivity with the RF-Gain potentiometer, turn it counter clockwise.

**Caution:** The Alarm Threshold is self-adapting.

### 3.4.4. DIL Switch Settings

- The recommended (default) DIL switch (S3-1 to S3-6) settings are the ON position. For an alternative setting see tables.

DIL Switch S3-1	S3-2	A / N Ratio	Description
ON	ON	3 : 1	Alarmthreshold to Noiselevel Ratio, for low signal Tag o r Label
OFF	ON	4.5 : 1	A / N Ratio
ON	OFF	6 : 1	A / N Ratio, for high signal Tag
OFF	OFF	7.5 : 1	A / N Ratio

DIL Switch S3-1 and S3-2 Table

DIL Switch S3	Position		Description
	ON (Default)	OFF	
S3 - 3	24	8	<b>Alarm Accept Counter:</b> - 24 Times, Alarm Conditions fulfilled - 8 Times, Alarm Conditions fulfilled
S3 - 4	----	----	Not implemented yet
S3 - 5	Normal	Alternate	<b>Baseband Filter:</b> - Normal Baseband Filter - Alternate BF, reduces low Q artefacts
S3 - 6	Enable	Disable	<b>Click Filter:</b> - Enable, Click Filter active - Disable, Click Filter not active

DIL Switch S3-3 until S3-6 Table

### 3.5. Alarm Adjustments

- Set Volume potentiometer R426 to the desired level.  
With Jumper J10 the sound can be changed from intermitted (= OUT) to continuous (default = IN).

**Remark:** The actual beeper version can only continuous (J10 IN or OUT).  
External Alarm Connector X3 (see Appendix).

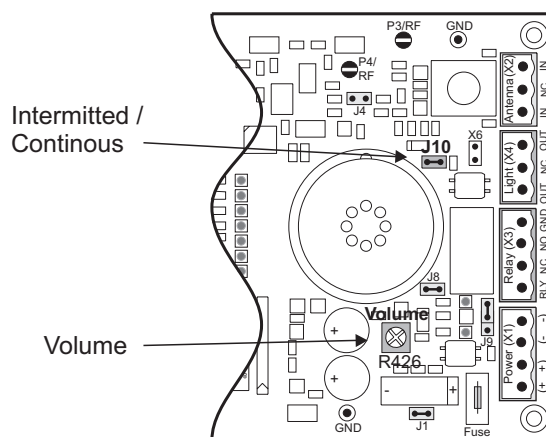

Sound Controls

### 3.6. Quick Check

#### 3.6.1. Basics

For a Quick Check, the Rotary switch (0 to F9) can be turned to different Test positions. The LED "Test" indicates that the Rotary switch is not anymore in the standard (0) position. The three yellow Indicator LED's are used as a Levelmeter. The Quick Check Procedure is no full replacement of the real tuning as described in chapters 3.4 – 3.5. Especially the proper setting of the beat note level needs to be done with the help of an oscilloscope.

#### 3.6.2. RF-Gain Check

- Set Rotary switch to position 7 (RF-Gain Check / Adjustment). The Test LED is lit. Let all DIL switches in their ON position.

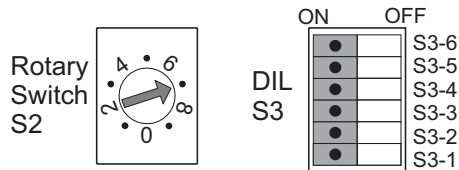

- Turn the RF-Gain potentiometer R112 until only the Center LED of the Levelmeter is ON.  
Note: Before start turn the RF-Gain potentiometer fully counter clockwise.

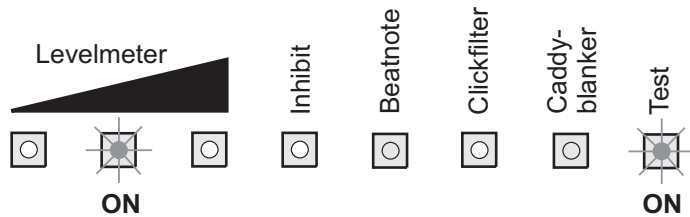

#### RF-Gain Check/Adjustment

Levelmeter	Action
	Turn from fully counter clockwise until a yellow LED goes on.
	Turn clockwise to find the yellow Center LED.
	Turn slowly clockwise until only the yellow Center LED is on.
	<b>OK, Perfect</b>
	Turn slowly counter clockwise until the yellow Center LED is on.
	Turn counter clockwise to find the yellow Center LED.

#### Step by Step RF-Gain Adjustment

**Remark:** If the RF-Gain is much too high, the third of the Levelmeter and the Inhibit LED will be on.

### 3.6.3. Beat Note Check

**Note:** The Beat Note Adjustment can't be done in a Quick Mode, for a correct adjustment and to find indications about the source of problems see chapter 3.4.2.

- Set Rotary switch to position 0 (Running/Default Mode).

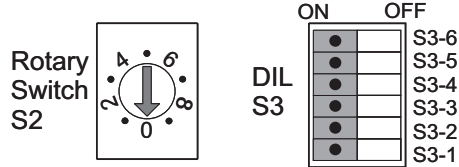

- Check if the Beat Note LED is:
  - **OFF**, no disturbing signal is around or the circuit is inactive.
  - **Sporadic flashing**, the Beat Note is inhibiting some signals (no sensitivity loss).
  - **Quick constant flashing**, wrong adjustment or too much disturbance signals (sensitivity loss).
  - **Constant ON**, System is blocked.

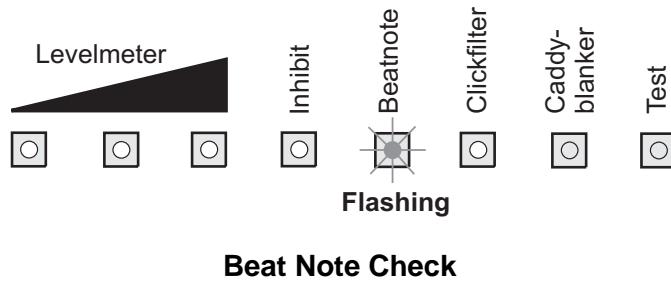





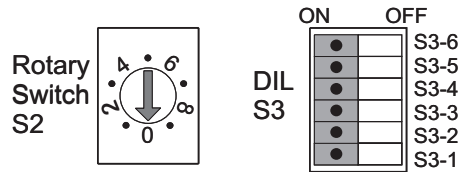

### 3.6.4. Signal/Noise Check

- Set Rotary switch to position 0 (Running/Default Mode).

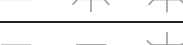

- Check the Signal Noise Level according to the table below.

Levelmeter 	Noise / Explanation
	< 100 mVpp Ideal (Wide Exit)
	100 - 150 mVpp Typical / Good (Wide Exit)
	150 - 200 mVpp Typical / Acceptable (Not recommended for wide exit system)
	200 - 250 mVpp Acceptable (Not recommended for wide exit system)
	250 - 300 mVpp Worst case (Not recommended for wide exit system)
	300 - mVpp Unacceptable (Not recommended for wide exit system)

**Signal/Noise Level Table**

- Hint:**
- In a good installation all three yellow LED's are OFF or the first LED is sometimes flickering.
  - The worst acceptable case for a wide exit installation using series 400 labels is:
    - First LED continuous ON and the second LED flickering.

## 4. Appendix

### 4.1. Technical Specifications

#### Receiver Board URB-100

##### Electronics

RF Frequency Range	7.2 – 9.2 MHz
Synchronization Frequency Range	78 – 86 Hz (82 Hz default)
RF Signal Input Range (Antenna)	10 – 70 mVpp (30 – 210 mVpp with attenuator)
Antenna Input Impedance	200 Ohm
DSP Performance	40 MIPS
RF Gain	Adjustable
Beat Note	Adjustable

##### Switches

S1	Push Button (Factory)
S2	Rotary (Check and Test Purposes)
S3	DIL (System Parameters)

##### Status Indicators

Power	Green LED
Alarm, Test, Beat, Click, Spike, Inhibit	Red LED's
Levelmeter	3 yellow LED's

##### Alarm Controls

Buzzer	Volume, adjustable to maximum 95 dB Sound Time, approx. 2 seconds
Light	Light Time, approx. 10 seconds

##### Connectors

X1	Power (DC or AC)
X2	Antenna (Antenna Matching Board)
X3	External Alarm
X4	Alarm Lamp of Antenna
X5	JTAG (Factory use only)
X6	Optional Buzzer
X7	Serial
X18	Video

##### Power Voltage Range

AC Input	18 – 20 VAC at 150 mA
DC Input	20 – 24 VDC

Alarm Light Consumption max. 500 mA

Fuse 800 mA, quick - acting F





### 4.3. X3 Connector Layout (External Alarm Unit)

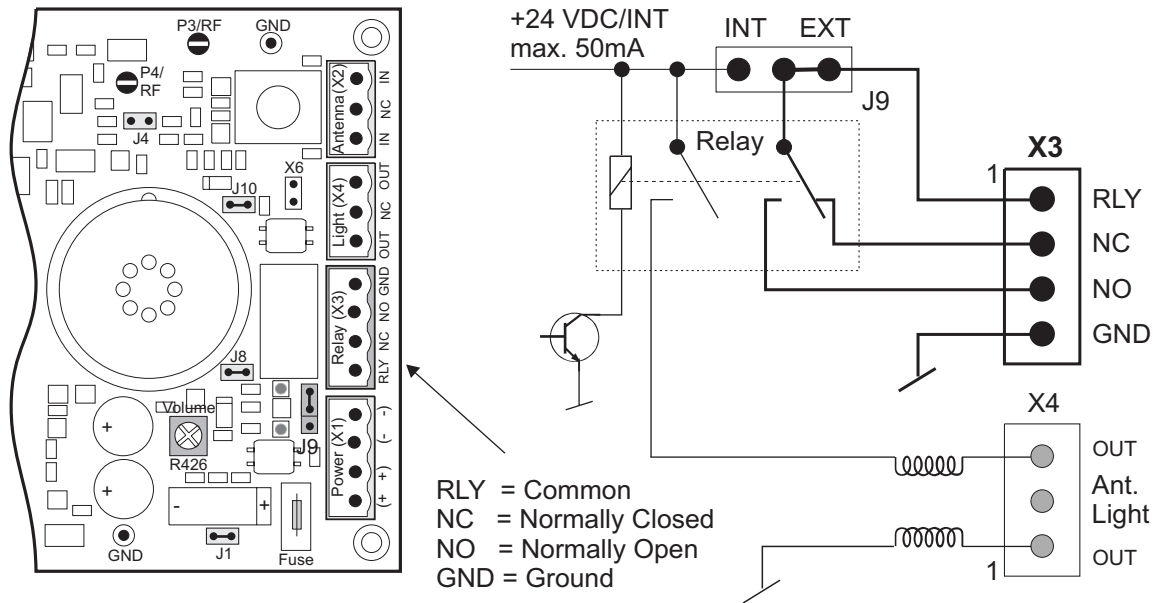

**X3 Connector Layout**

**Caution:** If the internal 24 VDC is used, an additional DC Filter must be mounted into the external lines. The DC Filter must be positioned directly by the X3 connector to protect the RX board from external disturbance.

Relay data:

Contact Ratings:

Max. switching voltage	48VAC or 48VDC
Max. switching current	1A

**Warning:**

**Never connect 230 / 110 Volt to connector X3. Dangerous voltage, capable of causing death.**

#### 4.4. DIL Switch Settings

DIL Switch S3		A / N Ratio	Description
S3-1	S3-2		
ON	ON	3 : 1	Alarmthreshold to Noiselevel Ratio, for low signal Tag o r Label
OFF	ON	4.5 : 1	A / N Ratio
ON	OFF	6 : 1	A / N Ratio, for high signal Tag
OFF	OFF	7.5 : 1	A / N Ratio

**DIL Switch Table**

DIL Switch S3	Position		Description
	ON (Default)	OFF	
S3 - 3	<b>24</b>	8	<b>Alarm Accept Counter:</b> - 24 Times, Alarm Conditions fulfilled - 8 Times, Alarm Conditions fulfilled
S3 - 4	-----	-----	Not implemented yet
S3 - 5	<b>Normal</b>	Alternate	<b>Baseband Filter:</b> - Normal Baseband Filter - Alternate BF, reduces low Q artefacts
S3 - 6	<b>Enable</b>	Disable	<b>Click Filter:</b> - Enable, Click Filter active - Disable, Click Filter not active

**DIL Switch Table**

## 4.5. Rotary Switch Settings

Rotary Switch S2 Settings	Description	used for
<b>0</b>	<b>Running / Default Mode (default position)</b>	<b>Default</b>
1+S1	Temporarily blocked Alarm Threshold (for tests only)	Test
2	LF signal only (without alarm threshold)	Check
3	LF signal before correlator	Check
4	LF signal equal pos.3, with additional beat note blanking	Adjustment
5	LF signal equal pos.4, with additional click filter blanking	Check
6	LF signal equal pos.5, with additional correlator filter	Check
7	RF-Gain Adjustment	Adjustment/Check
8	Not used (factory only)	Factory
9	Not used (factory only)	Factory

**Rotary Switch Table**

## 4.6. Test Points

Test Points		Description
Test Point	Labeled	
P 1	RF	RF Signal before Demodulator
P 2	LF	LF Signal, a demodulated RF Signal before the Linear Phase Filter
P 3	RF	RF Signal after the Antenna Input Transformator
P 4	RF	RF Signal before Bandpass Filter
P 5	LF	RF Signal after Bandpass Filter
P 6	Beat	Beat Note
P 7	Beat	Beat Note, Blank Signal
P 8	FS	Frame Sync (DSP)
P 9	MOD	Modulator
P 10	Sync	Synchronisation
P 11	Video	Video Signal, Sync Signal included
X18	Video	Video Signal, Sync Signal included
X5	JTAG	Factory use only
X7	Serial	Factory use only

**Test Points Table**

## 4.7. Jumper Settings

Jumper	Settings	Meaning
(J1)	<b>IN*</b> OUT	Connects the unregulated +24 VDC to the voltage regulators Factory use only
(J2)	<b>IN*</b> OUT	Connects the regulated +12 VDC to the RF circuits Factory use only
(J3)	<b>IN*</b> OUT	Connects the regulated +5 VDC to the digital circuits Factory use only
<b>J4</b>	IN <b>OUT*</b>	Narrow = Pre-Amplifier gain reduction Wide = No gain reduction
(J5)	<b>IN*</b> OUT	Connects the regulated +12 VDC to the LF circuits Factory use only
(J6)	<b>IN*(WD)</b> OUT(R)	Watchdog active Reset, factory use only
(J7)	<b>IN*(1-2)</b> OUT(3-4)	Synchronization for the DSP Factory use only
<b>J8</b>	<b>IN*</b> OUT	Sound active (ON) Sound inactive (OFF)
<b>J9</b>	<b>IN*(EXT)</b> OUT(INT)	External alarm (X3) supplied by external voltage supply External alarm (X3) supplied by internal +24 VDC, max. 50 mA
<b>J10</b>	<b>IN*</b> OUT	Continuous alarm sound Intermittent alarm sound

**Jumper Settings Table**

**Agenda:**

- ( ) For factory use only
- \* Default setting

### 4.8. Compressed Overview

Rotary Switch S2 Settings	Description	used for
<b>0</b>	<b>Running / Default Mode (default position)</b>	<b>Default</b>
1+S1	Temporarily blocked Alarm Threshold (for tests only)	Test
2	LF signal only (without alarm threshold)	Check
3	LF signal before correlator	Check
4	LF signal equal pos.3, with additional beat note blanking	Adjustment
5	LF signal equal pos.4, with additional click filter blanking	Check
6	LF signal equal pos.5, with additional correlator filter	Check
7	RF-Gain Adjustment	Adjustment/Check
8	Not used (factory only)	Factory
9	Not used (factory only)	Factory

Jumpers	Settings	Meaning
(J1)		Connects the unregulated +24 VDC to the voltage regulators (default) Factory use only
(J2)		Connects the regulated +12VDC to the RF circuits (default) Factory use only
(J3)		Connects the regulated +5 VDC to the digital circuits (default) Factory use only
<b>J4</b>		Narrow = Pie-Amplifier gain reduction Wide = No gain reduction (default)
(J5)		Connects the regulated +12VDC to the LF circuits (default) Factory use only
(J6)		WD Watchdog active R Reset, factory use only (default)
(J7)		Synchronization for the DSP Factory use only (default)
<b>J8</b>		Sound active (ON) Sound inactive (OFF) (default)
<b>J9</b>		External alarm (X3) supplied by external voltage supply (default) External alarm (X3) supplied by internal +24 VDC, max. 50 mA
<b>J10</b>		(special Option) (default)

LED	Color if active	Function	OFF	ON	Flashing
1	Green	VU Meter			
2	Green	VU Meter			
3	Green	VU Meter			
4	Red	Inhibit	Normal	RF high	
5	Red	Beatnote	Normal	*****	Beatnote active
6	Red	Clickfilter	Normal	*****	Clickfilter active
7	Red	Caddy-Blanker	Normal	*****	Caddy-Blanker active
8	Red	Testmode	DSP failure	Testmode	Normal

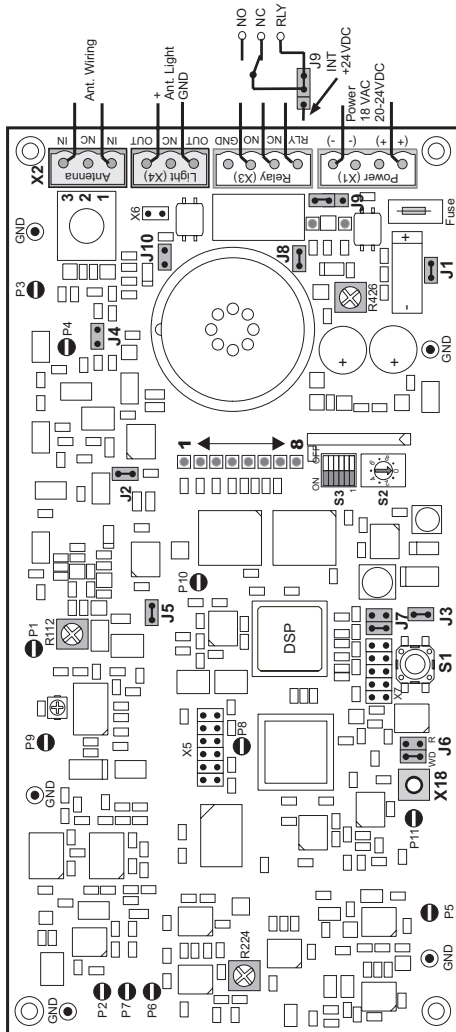

Test Point	Label	Description
P 1	RF	RF Signal before Demodulator
P 2	LF	LF Signal, a demodulated RF Signal before the Linear Phase Filter
P 3	RF	RF Signal after the Antenna Input Transform.
P 4	RF	RF Signal before Bandpass Filter
P 5	LF	RF Signal after Bandpass Filter
P 6	Beat	Beat Note
P 7	Beat	Beat Note, Blank Signal
P 8	FS	Frame Sync (DSP)
P 9	MOD	Modulator
P 10	Sync	Synchronisation
P 11	Video	Video Signal, Sync Signal included
X18	Video	Video Signal, Sync Signal included
X5	JTAG	Factory use only
X7	Serial	Factory use only

DIL Switch S3	=ON	X	=default	=OFF
<b>Alarm threshold to Noise level Ratio</b>				
Ratio	4.5:1	7.5:1	3:1	6:1
S3-1	X	X		
S3-2			X	X
S3-3			X	24 times
S3-4			X	8 times
S3-5			X	not implemented yet
S3-6			X	Normal
			X	Alternate, reduces low Q Artefacts
S3-6			X	Enable (active)
			X	Disable (inactive)

